



S4401

Bryce Series

Apron Kitchen Sink

Features

- Curved Apron Front
- 16 Gauge 304 Stainless Steel Construction
- Satin Brushed Finish
- Non-Porous Corrosion-Resistant Surface
- Equipped with SoundShield™ Noise Deadening Pads (85% Bottom Basin Coverage)
- Protected with a Non-Toxic Anti-Condensation Coating
- Self-trimming design only requires a simple rough cut overlapping cabinet face for easy installation
- Limited Lifetime Warranty



Compatible Accessories

TG21, TG22 Stainless Steel Custom Fit Basin Rack
SC1 Deluxe Sink Caddy
TBASK Stainless Steel Basket Strainer
MF1 FuFu Microfiber Sink Loofah
T4401 Sink Cut-Out Template
Installation Instructions

Codes/Standards

ASME A112.19.3/CSA B45.4

1-(503) 455-8336

Sink specifications may change without notice. Please visit www.ticorsinks.com for the most current information. Updated 03/21/2018



S4401

Bryce Series

Apron Kitchen Sink

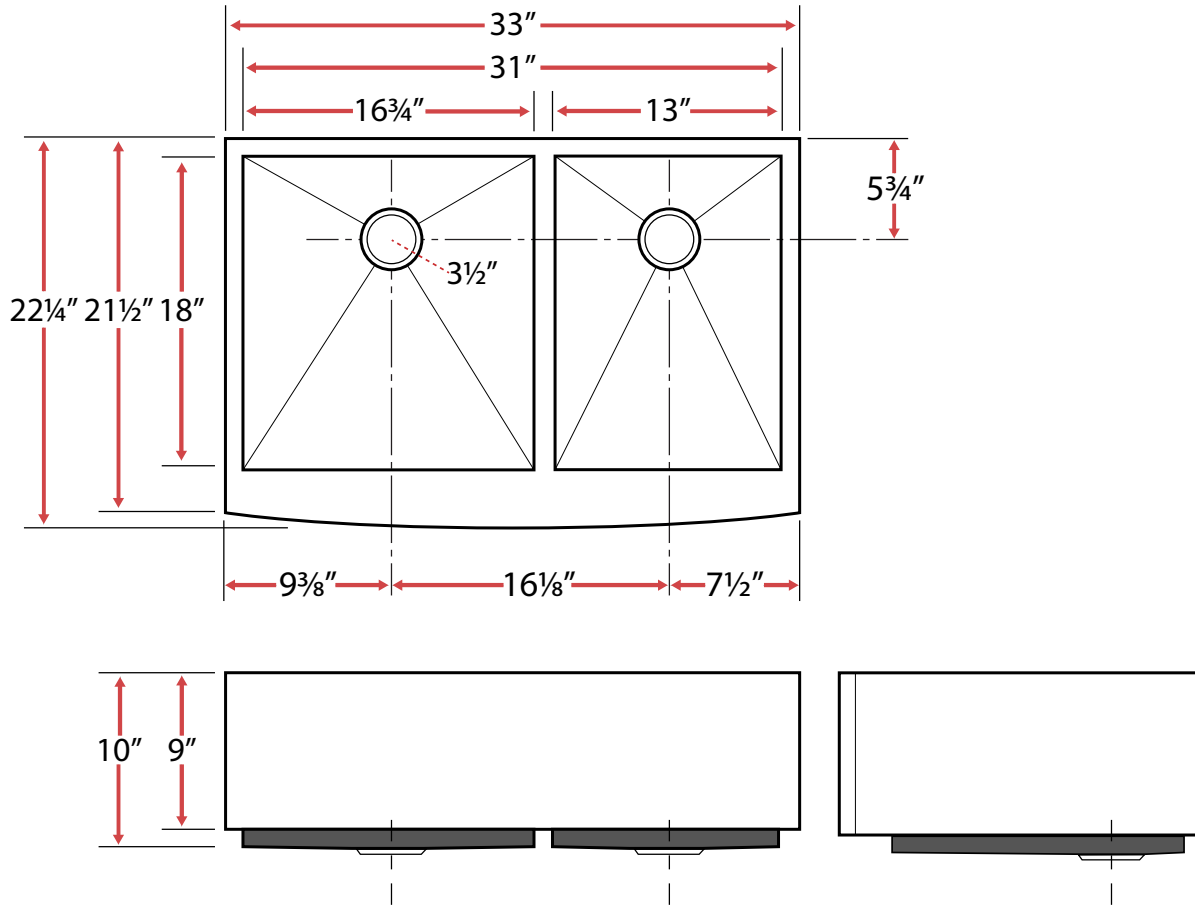

Technical Information

- Sink Collection: **Bryce Series**
- Sink Model Number: **S4401**
- Corner Style: **Zero Radius**
- Sink Length (inches): **33**
- Sink Width (inches): **22 1/4**
- Sink Basin Depth (inches): **10**
- Sink Apron (inches): **9**
- Drain Opening (inches): **3.5**
- Drain Position: **Rear**
- Bowl Configuration: **Double**
- Bowl Ratio: **57/43**
- Installation Type: **Undermount/Flush-Mount**
- Minimum Sink Base Cabinet Width Required: **33"**

(Cabinet May Require Additional Modifications at Minimum Size. Consult an Installer for Confirmation)

1-(503) 455-8336

Sink specifications may change without notice. Please visit www.ticorsinks.com for the most current information. Updated 03/21/2018