



S3610

Pacific Series

Undermount Kitchen/Bar Sink

Features

- 16 Gauge 304 Stainless Steel Construction
- Satin Brushed Finish
- Non-Porous Corrosion-Resistant Surface
- Equipped with SoundShield™ Noise Deadening Pads (85% Bottom Basin Coverage)
- Protected with a Non-Toxic Anti-Condensation Coating
- Limited Lifetime Warranty

Compatible Accessories

TG29 Stainless Steel Custom Fit Basin Rack
SC1 Deluxe Sink Caddy
TBASK Stainless Steel Basket Strainer
MF1 FuFu Microfiber Sink Loofah
MIB-U Mounting and Installation Brackets
T3610 Sink Cut-Out Template
Installation Instructions



Codes/Standards

ASME A112.19.3/CSA B45.4



S3610

Pacific Series

Undermount Kitchen/Bar Sink

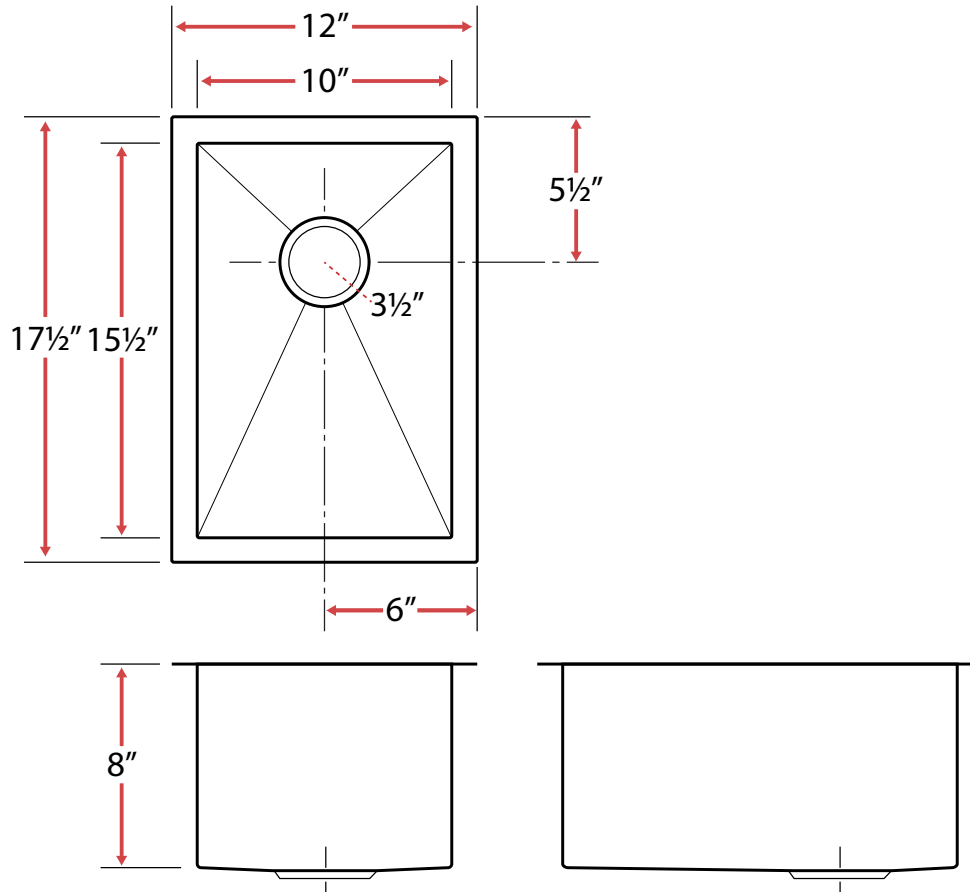

Technical Information

- Sink Collection: **Pacific Series**
- Sink Model Number: **S3610**
- Corner Style: **Zero Radius**
- Sink Length (inches): **12**
- Sink Width (inches): **17 1/2**
- Sink Basin Depth (inches): **8**
- Drain Opening (inches): **3.5**
- Drain Position: **Rear**
- Bowl Configuration: **Single**
- Installation Type: **Undermount**
- Minimum Sink Base Cabinet Width Required: **15"**

(Cabinet May Require Additional Modifications at Minimum Size. Consult an Installer for Confirmation)

1-(503) 455-8336

Sink specifications may change without notice. Please visit www.ticorsinks.com for the most current information. Updated 03/21/2018