



S3510

Pacific Series

Undermount Kitchen Sink

Features

- 16 Gauge 304 Stainless Steel Construction
- Satin Brushed Finish
- Non-Porous Corrosion-Resistant Surface
- Equipped with SoundShield™ Noise Deadening Pads (85% Bottom Basin Coverage)
- Protected with a Non-Toxic Anti-Condensation Coating
- Limited Lifetime Warranty



Compatible Accessories

TG20 Stainless Steel Custom Fit Basin Rack
RSR1912 Stainless Steel Rolling Rack
SC1 Deluxe Sink Caddy
TBASK Stainless Steel Basket Strainer
MF1 FuFu Microfiber Sink Loofah
MIB-U Mounting and Installation Brackets
T3510 Sink Cut-Out Template
Installation Instructions

Codes/Standards

ASME A112.19.3/CSA B45.4



S3510

Pacific Series

Undermount Kitchen Sink

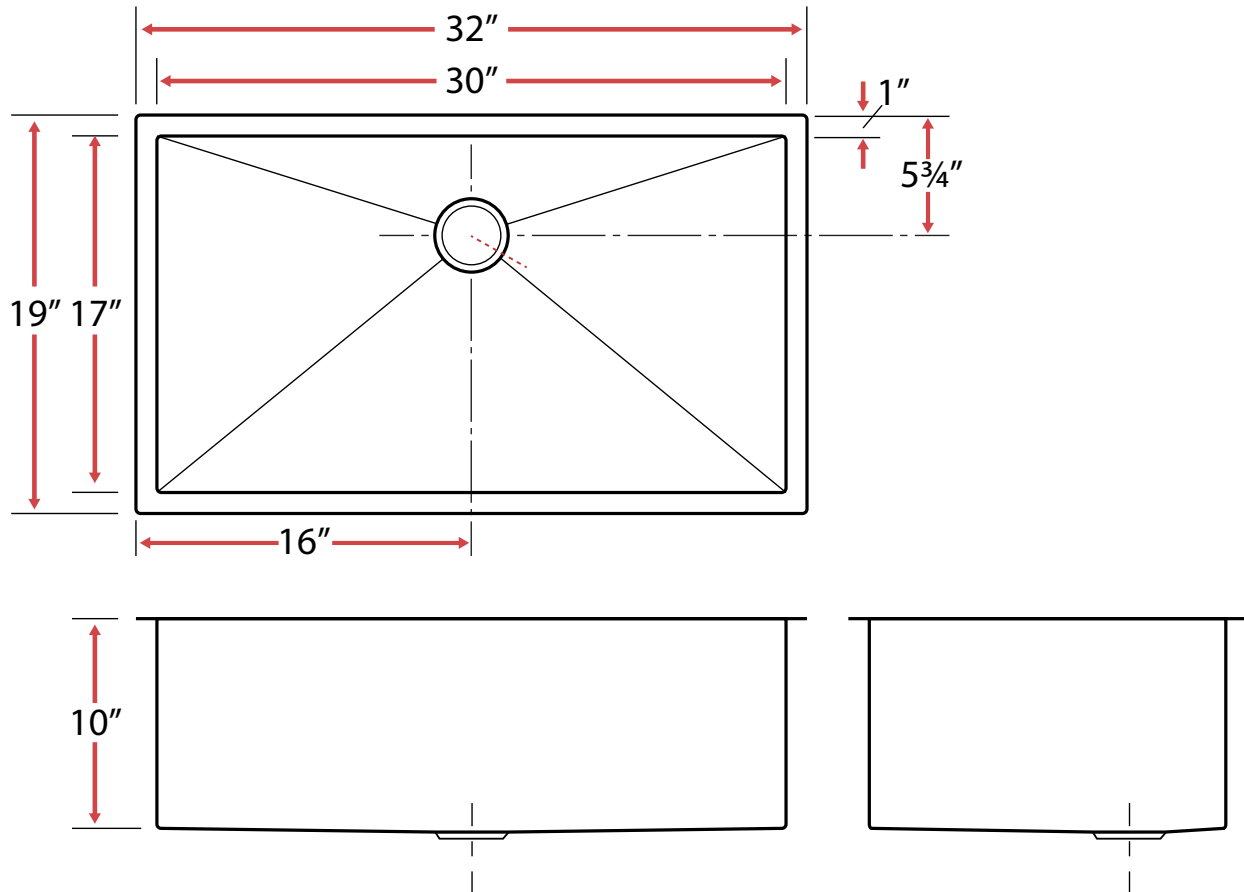

Technical Information

- Sink Collection: **Pacific Series**
- Sink Model Number: **S3510**
- Corner Style: **Zero Radius**
- Sink Length (inches): **32**
- Sink Width (inches): **19**
- Sink Basin Depth (inches): **10**
- Drain Opening (inches): **3.5**
- Drain Position: **Rear**
- Bowl Configuration: **Single**
- Installation Type: **Undermount**
- Minimum Sink Base Cabinet Width Required: **33"**

(Cabinet May Require Additional Modifications at Minimum Size. Consult an Installer for Confirmation)

1-(503) 455-8336

Sink specifications may change without notice. Please visit www.ticorsinks.com for the most current information. Updated 03/22/2018